



T Plus DC Probe Wedge / Model: MC 34

(Max 34pin model)

Electric Performance

Characteristic impedance	-
Frequency range	DC
DC voltage	100V
DC current	1A
RF Power @ 10GHz max	5W
Contact resistance on Au	0.05 ohm

Mechanical Performance

Probe Material (for DC / DC GND)	Tungsten or BeCu
Body Material	Aluminum Alloy
PCB Material	FR4
Pin Count	Min 1 / Max 34
Contact pressure @2mil Over travel	TBD
Contact Cycle (Auto Probe Mode)	1A
XY position error	Max 10um
Planarity error	Max 10um
Scribing mark (Width)	Min 15um / Max TBD
Available Pitch	Min 50um / Max TBD
Connector	2.54mm Pin header / or Coax+BNC or SMA

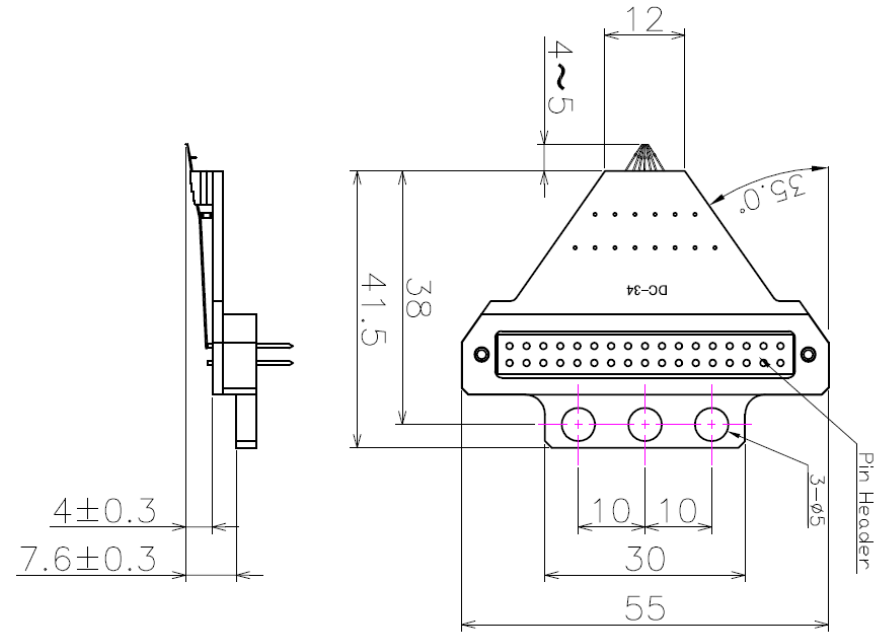

Unit: mm
Tolerance: +/-0.25

Decoupling Capacitor Option

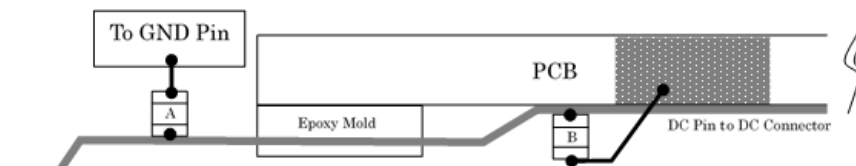

Location A = 100pF

Location B = 0.1uF